

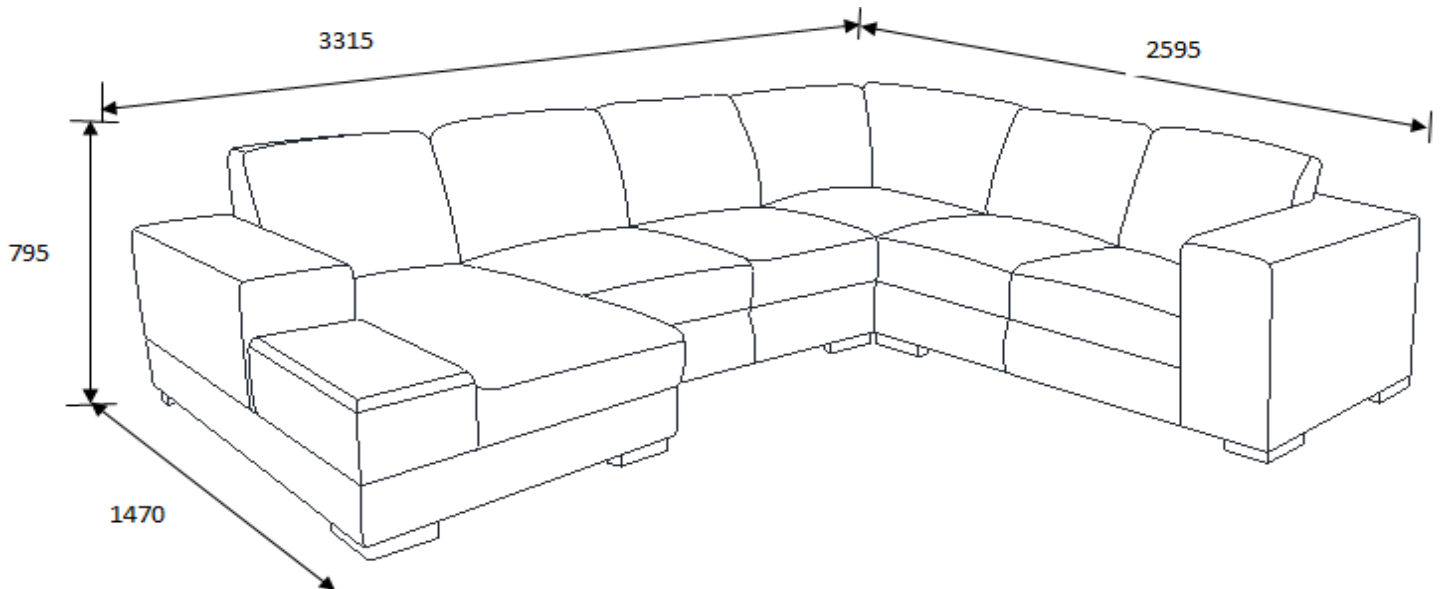

ASSEMBLY INSTRUCTION
LIVERPOOL CORNER LOUNGE

ITEM CODE - 66911

Imported by Amart Furniture Pty Ltd, Qld, Brisbane Australia.
For any assistance with assembly or for missing parts please
phone Amart Furniture, Customer Service Free call 1800 351 084





Imported by Amart Furniture Pty Ltd, Qld, Brisbane Australia.
For any assistance with assembly or for missing parts please phone Amart
Furniture, Customer Service Free call 1800 351 084

PRE-ASSEMBLY PREPARATION

BEFORE YOU START...





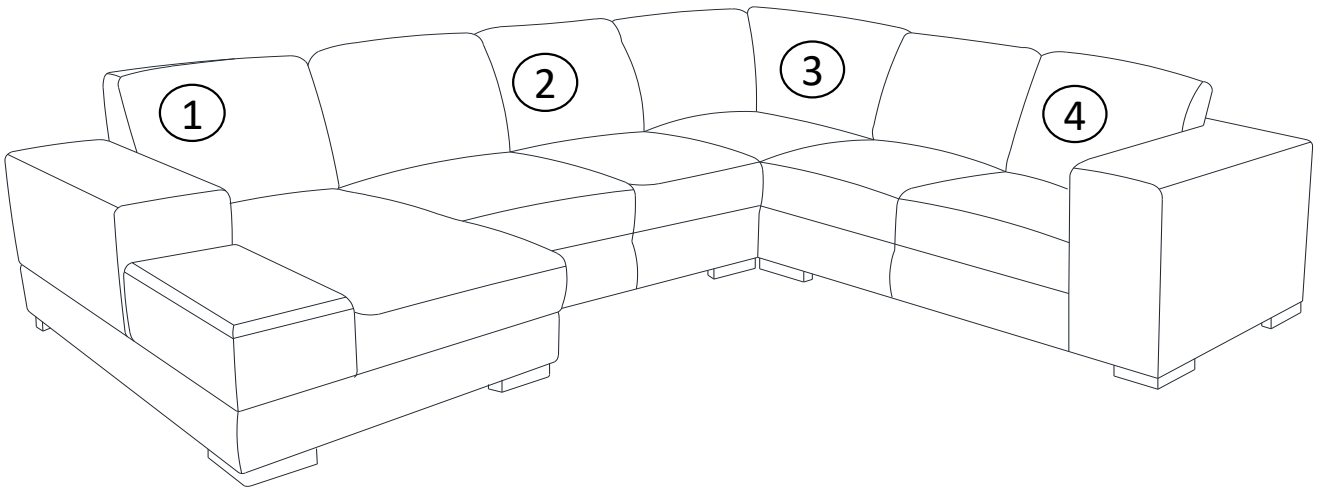

1. CHOOSE A CLEAN, LEVEL, SPACIOUS ASSEMBLY AREA. AVOID HARD SURFACES THAT MAY DAMAGE THE PRODUCT.
2. TAKE CARE WHEN LIFTING. PRODUCT SHOULD BE ASSEMBLED AS NEAR AS POSSIBLE TO THE POINT OF USE.
3. CHECK AND ENSURE THAT YOU HAVE ALL THE REQUIRED CONTENTS FOR COMPLETE ASSEMBLY.
4. ALWAYS READ THE ASSEMBLY INSTRUCTIONS CAREFULLY BEFORE BEGINNING ASSEMBLY.
5. THE PACKAGING AND CONTENTS CAN BE CHOKING HAZARDS, THEREFORE KEEP OUT OF REACH OF SMALL CHILDREN AT ALL TIMES.
6. DO NOT OVER TIGHTEN THE SCREWS AND BOLTS AS THIS MAY DAMAGE THE THREADS.

	
ALLOW 20 MINUTES	2 PEOPLE REQUIRED
	
ADDITIONAL TOOLS REQUIRED	



PARTS LIST









Hardware List (Pack 1)

NO.	DESCRIPTION		QTY
B	WOODEN LEG L		3 PCS
D	M5 ALLEN KEY		1 PC
E	WOODEN LEG M		1 PC
F	M8 x 60MM BOLT		4 PCS
G	PVC LEG		1 PC
H	CHIPBOARD SCREW M4X50MM		1 PC





Hardware List (Pack 2)

NO.	DESCRIPTION		QTY
D	M5 ALLEN KEY		1 PC
E	WOODEN LEG M		4 PCS
F	M8 x 60MM BOLT		4 PCS

Hardware List (Pack 3)

NO.	DESCRIPTION		QTY
A	CHIPBOARD SCREW M4X38MM		1 PC
B	WOODEN LEG L		1 PC
C	PVC LEG		1 PC
D	M5 ALLEN KEY		1 PC
E	WOODEN LEG M		2 PCS
F	M8 x 60MM BOLT		3 PCS

Hardware List (Pack 4)

NO.	DESCRIPTION		QTY
B	WOODEN LEG L		2 PCS
D	M5 ALLEN KEY		1 PC
E	WOODEN LEG M		2 PCS
F	M8 x 60MM BOLT		4 PCS

PLEASE TAKE NOTE: PIECES REQUIRE FOR ASSEMBLY ARE LOCATED INSIDE THE DUST COVER UNDERNEATH SOFA

Step 1

LIFT THE ITEM WITH 2 PEOPLE CAREFULLY TURN OVER ONTO BLANKET OR CARPET TO ENSURE NO DAMAGE TO ITEM.

- DETAILS (1) - Align base plate of each foot (B) with the pre-threaded holes in the undersides of the sofa as shown in the below diagram. Insert Bolt (F) and tighten by turning clockwise using Allen key (D)
- DETAILS (2) - Align base plate of each foot (E) with the pre-threaded holes in the undersides of the sofa as shown in the below diagram. Insert Bolt (F) and tighten by turning clockwise using Allen key (D)
- DETAILS (3) - Align base plate of each foot (C) with the pre-threaded holes in the undersides of the sofa as shown in the below diagram. Insert Bolt (A) and tighten by turning clockwise.
- DETAILS (4) - Align base plate of each foot (G) with the pre-threaded holes in the undersides of the sofa as shown in the below diagram. Insert Bolt (H) and tighten by turning clockwise.

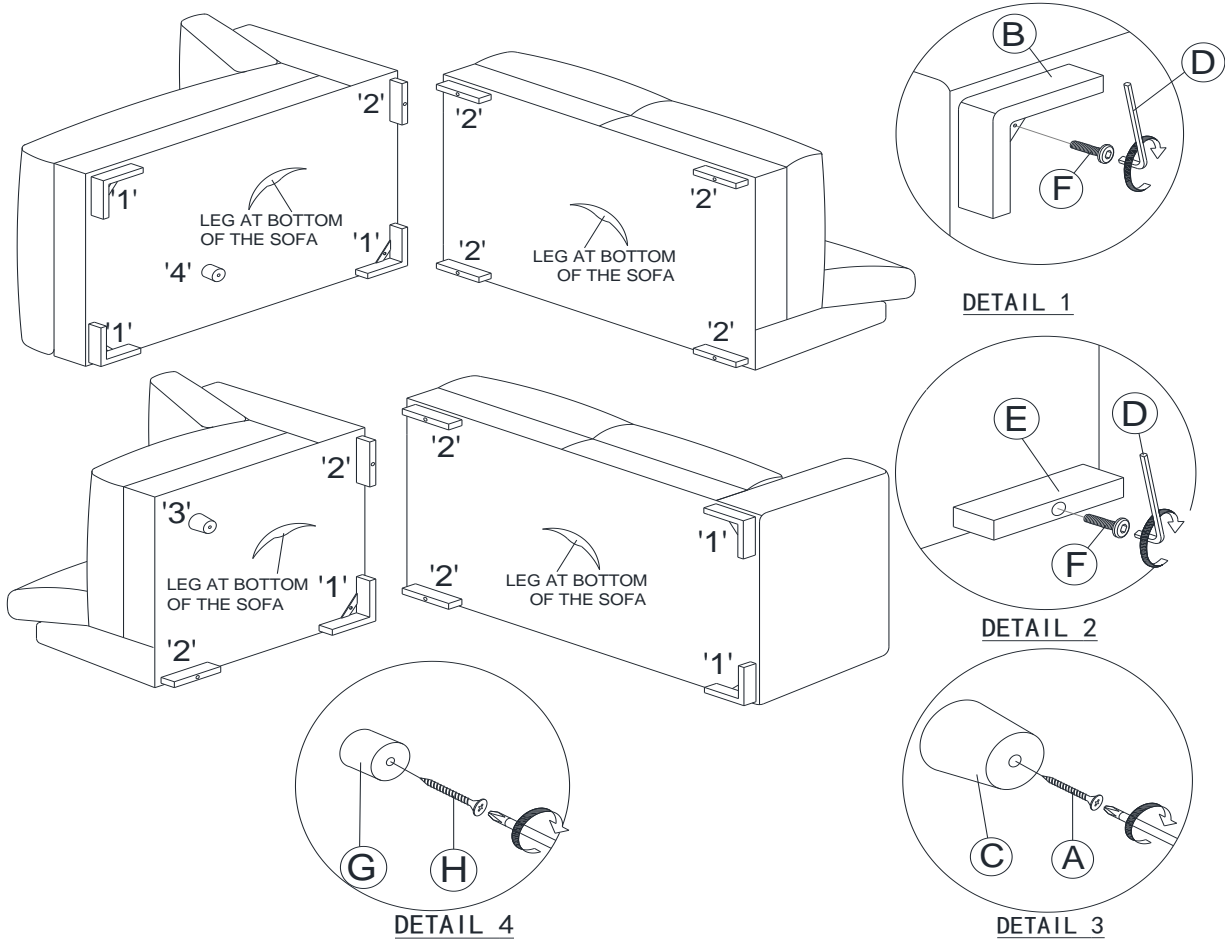

Step 2

- BEFORE CONNECTING THE LOUNGES, PLEASE TURN UPRIGHT THE LOUNGE WITH 2 PEOPLE CAREFULLY.

TO CONNECT THE LOUNGES LIFT THE END OF PIECE 1 WHERE THE BRACKETS ARE LOCATED AND SLIDE THEM DOWN ONTO THOSE LOCATED ON PIECE 2. MAKE SURE THEY CLICK FIRMLY INTO PLACE.

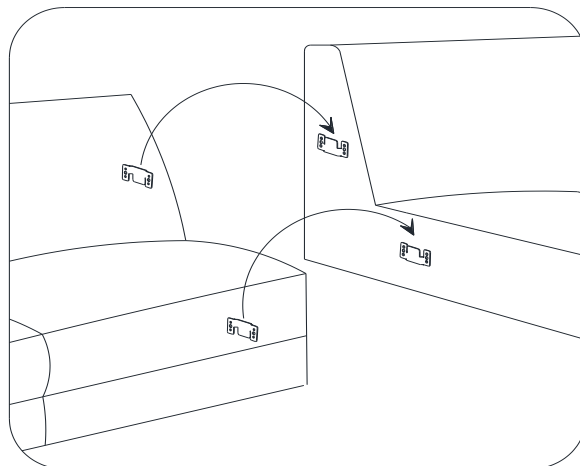

ASSEMBLY COMPLETED

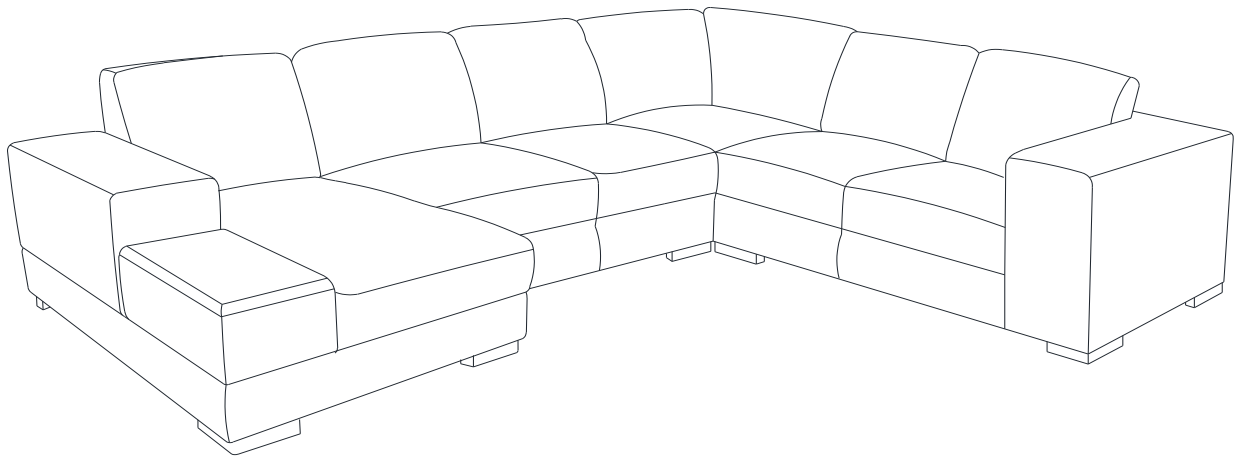

IMPORTANT: PLEASE ENSURE FEET ARE TIGHTENED SECURELY BEFORE USE!
WARNING - Do not drag lounge on any surface due to timber base, must be lifted.
Two Person Lift Recommended

CARE AND MAINTENANCE

LEATHER CARE (FRAME)

WHEN NECESSARY BRUSH OR VACUUM AWAY DUST AND GRIT. WIPE OVER WITH A SOFT, CLEAN, DYEFAST CLOTH.

FOR SPOTS AND SPILLS:

WIPE EXCESS LIQUID UP IMMEDIATELY WITH AN ABSORBANT CLOTH OR SPONGE.

FOR OVERALL CLEANING:

WE RECOMMEND CLEANING EVERY 3-4 MONTHS WITH

- LEATHER CLEANER FOLLOWED BY APPLICATIONS OF
- LEATHER PROTECTOR.

ALWAYS FOLLOW DIRECTIONS ON PACKS.

NOTES:

ACCUMULATION OF PERSPIRATION AND BODY OILS ON ARMPADS, HEADREST ECT. MAY DAMAGE YOUR LEATHER - THESE AREAS MAY REQUIRE MORE FREQUENT CLEANING.

DO NOT EXPOSE LEATHER TO DIRECT SUNLIGHT; INTENSIVE HEAT; WEATHER; OR SOAK UNNECESSARILY. ALWAYS AVOID EXCESSIVE HARD RUBBING.

DO NOT DRY CLEAN OR MACHINE WASH.

DO NOT USE SADDLE SOAP; DETERGENTS; SOLVENTS; ABRASIVES; UNIDENTIFIED LEATHER CLEANERS; SUEDE CLEANERS OR ANY PRODUCTS CONTAINING SILICON OR SOLVENTS.